



AX Series – 50/60Hz Current Transformers

Applications

- Power Monitoring
- Current Measurement
- Instrumentation

Features

- High Output Voltage in small package
- Good Linearity over current range
- 2.5KV Isolation
- High Saturation current
- Operating temperature range -40 deg C to +120 deg C



Electrical Specifications @ 20°C

Part No	Turns	Current Rating in A	Winding Resistance Ω
AX-0500	500	5.0	32
AX-0750	750	7.5	55
AX-1000	1000	10.0	93
AX-1500	1500	15.0	140

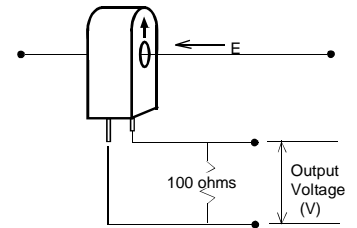
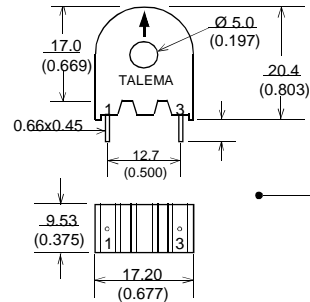

AX-0500

Output Voltage Vs Input Current

AX-0750

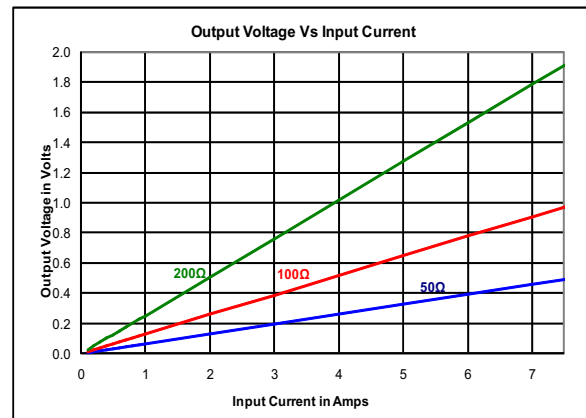
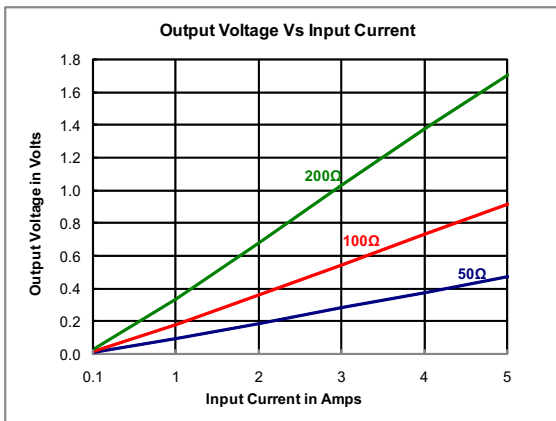

AX-1000

AX-1500

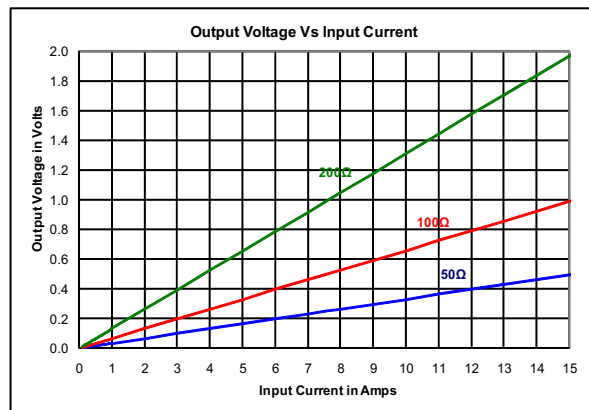
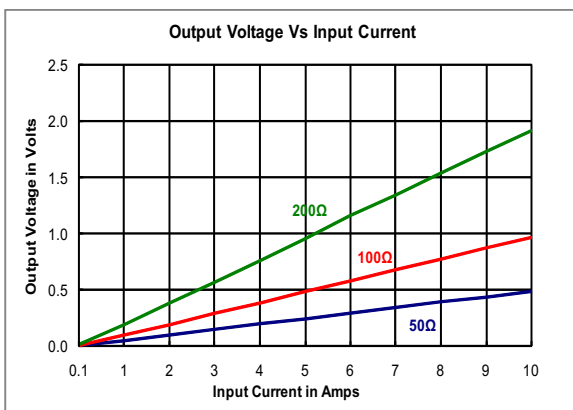



AX Series – 50/60Hz Current Transformers

AX-0500

Saturation Current Response

AX-0750

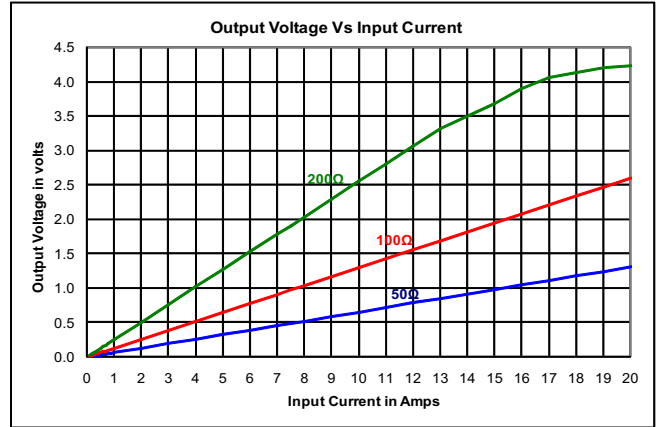
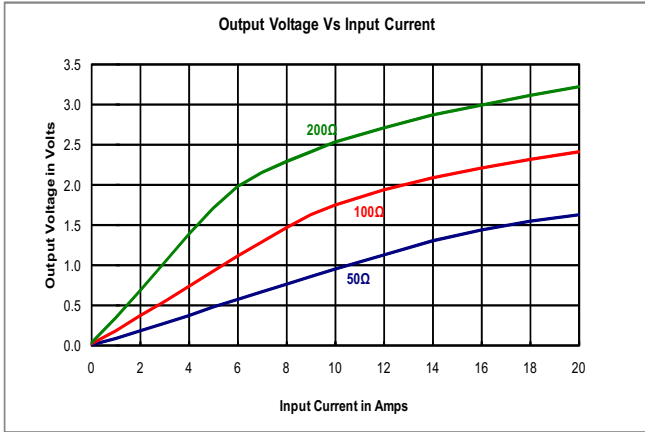

AX-1000

AX-1500

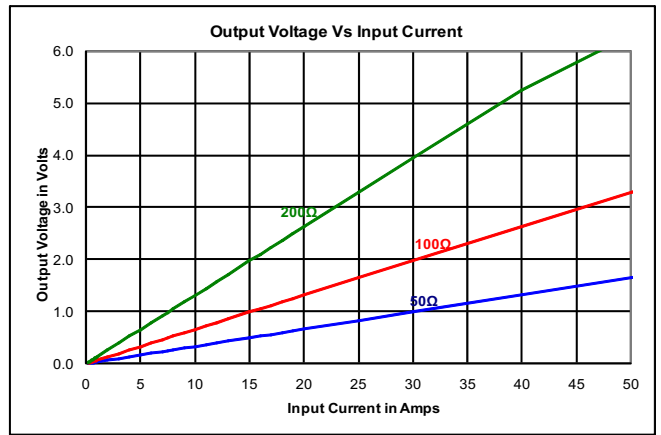
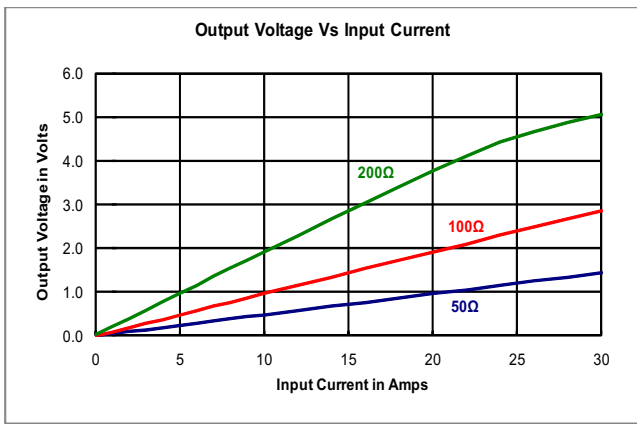

AX-0500

Phase Angle Vs Primary Current

AX-0750

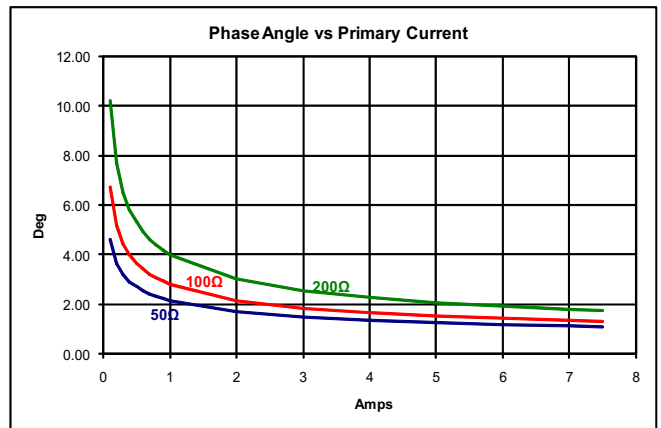
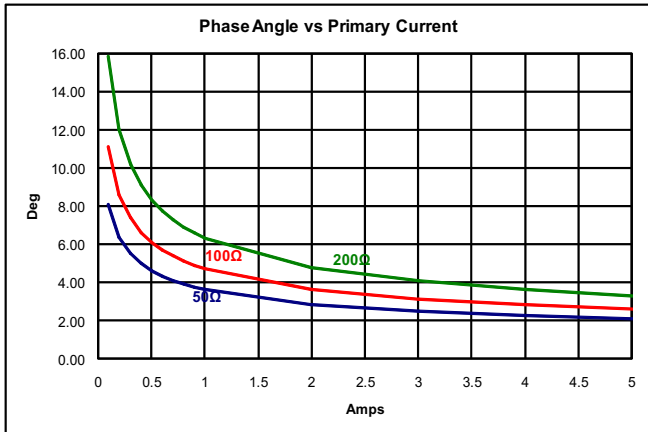

AX-1000

AX-1500

